

Zweiläufige Schurzugschiene für Store und Übergardine

Technische Eigenschaften

Farben: weiß-pulverbeschichtet, Schwarz auf Anfrage.
Montagepunkte alle 30 – 60 cm. Profil vorgebohrt.

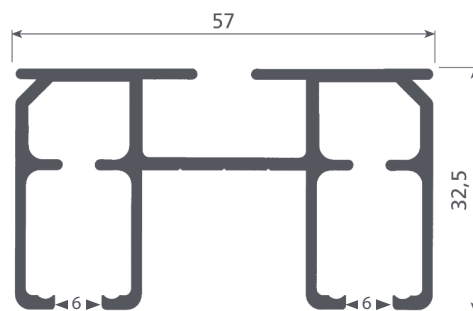

Garnituren

Inkl. Roller 5010, Haken 607, wahlweise Schnurhalter 8003 oder Schnurbeschwerer 5001.

Breite in cm	Anzahl Roller
200	20
250	25
300	30
350	35
400	40
450	45
500	50
550	55
600	60
650	65
700	70
750	75
800	80
850	85
900	90
950	95
1000	100
1050	105
1100	110
1150	115
1200	120
1250	125
1300	130
1350	135
1400	140
1450	145
1500	150
1550	155
1600	160

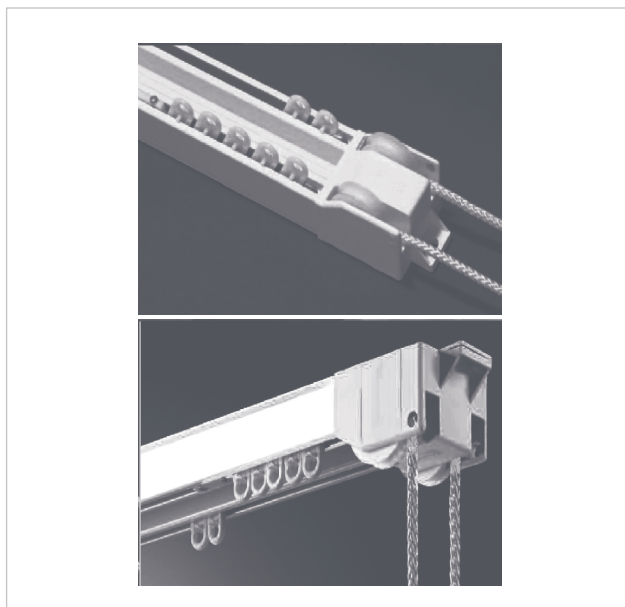

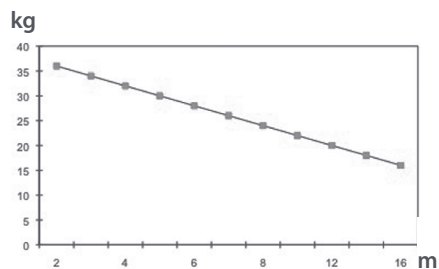

Belastungstabelle für gerade Anlagen



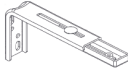

BESTELLN.R.	VPE
404 weiß	10 x 6 m

	BESTELLN.R.	VPE
Schienenverbinder		
	5087	1
Wandträger Metall, ausziehbar		
	100-150 mm 100-150 mm 150-230 mm 150-230 mm	weiß verzinkt weiß verzinkt
Abdeckkappe für Montagewinkel		
	2390 weiß/grau	1
Schnurbeschwerer 650 g		
	5088	1
Schnurbeschwerer 230 g		
	5001 weiß	1
Schnur- und Kettenhalter		
	8003 transparent	1
Schnurspanner Metall		
	8000 chrom 8001 weiß	1

	BESTELLN.R.	VPE
Haken Metall 20 mm		
	607	100
Haken Metall 40 mm		
	608	200
Roller mit drehbarer Öse		
	5010	100
Schwerlastroller mit Stahlachse		
	5011	100
Roller mit Gummirollen und Stahlachse		
	6011	100
Schnurspanner Kunststoff		
	8002 weiß	1
Schnurspanner Metall XXL		
	8004	1